

Eco Preparation 1200 mm Cupboard Sink with 2 Bowls

ITEM # _____

MODEL # _____

NAME # _____

SIS # _____

AIA # _____

132918 (ML2S1217N)

 Cupboard Sink with 2 bowls
 500x500mm, 1200mm

Short Form Specification

Item No. _____

Made entirely from stainless steel. Inner welded frame in stainless steel. Unique connection of panels to inner frame. Worktop in 304 AISI stainless steel (50mm high) incorporates a layer of sound deadening material and has upturned edges. Upstand (h=100mm)

Main Features

- Sturdiness, stability and reliability of table accurately tested.

Construction

- Inner welded frame in stainless steel to guarantee superior strength and stability.
- Handles directly built into the sliding doors.
- Easy access to the cupboard interior on all lengths guaranteed by the use of only 2 doors.
- Sturdy sound-deadened sliding doors on tracks located flush to the front of the frame.
- Constructed entirely in stainless steel to offer maximum durability.
- Constructed entirely in stainless steel to offer maximum durability.
- Wide range of taps are available to suit every need.
- 50 mm worktop in 304 AISI stainless steel.

Optional Accessories

- Wheel kit for cupboards, 4 wheels (2 with brakes), D=1000 mm PNC 855299
- Single plastic drain syphon 1,5 " for work tables with bowl PNC 855306
- Elbow operated mixer tap with spout 3/4", single hole PNC 855322
- Elbow operated mixer tap with short spout 3/4", single hole PNC 855323
- Foot operated mixer tap (hot and cold) with spout 3/4" PNC 855328

APPROVAL: _____

Front

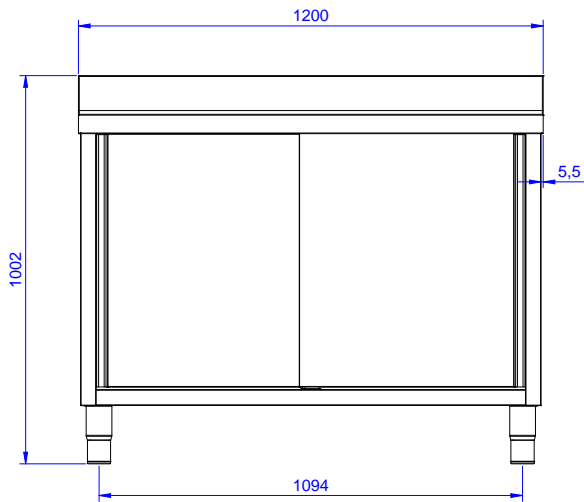

Side

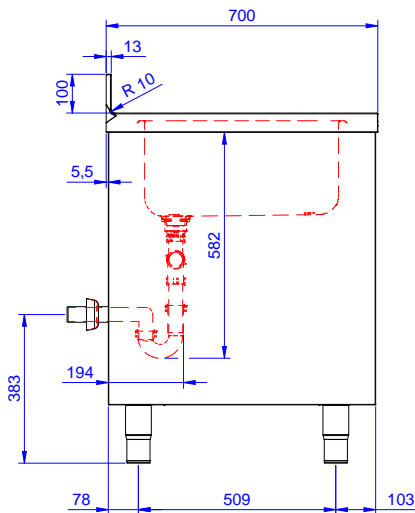

D = Drain

Top

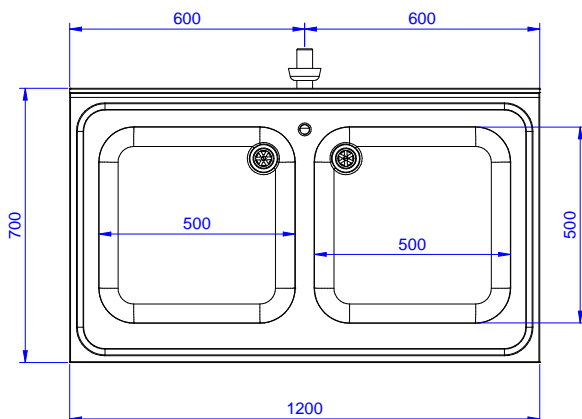
Key Information:

Cabinet width:		
132918 (ML2S1217N)	1145 mm	
Cabinet depth:	645 mm	
Cabinet height:	385 mm	
External dimensions, Width:	1200 mm	
External dimensions, Depth:	700 mm	
External dimensions, Height:	1000 mm	
Upstand Dimensions, Height:	100 mm	
Upstand Dimensions, Depth:	13 mm	
Upstand Dimensions, Radius:	R=10	
Bowls number	2	
Bowl dimensions	500x500xH250	
Number and type of doors:	2 Sliding	
Net weight:	55 kg	